

PRA/801000, PRA/803000, RA/801000, RA/803000 ISOLine™ 15552 cylinder, single acting

- > ø 32 ... 100 mm
- > High performance adaptive cushioning system "ACS"
- > High performance, stability and reliability

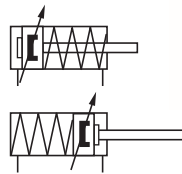

Technical features

Medium:

Compressed air, filtered, lubricated or non-lubricated

Standard:

ISO 15552

Note: all models conform to the mentioned standards except the cylinder length

Operation:

Single acting, adjustable cushioning

Operating pressure:

ø 32 ... 100 mm
2 ... 10 bar (29 ... 145 psi)

Ports:

G1/8 ... 1/2

Cylinder diameters:

32, 40, 50, 63, 80, 100 mm

Standard strokes:

25, 50, 80, 100 mm

Non-standard strokes:

Available (5 ... 250 mm)

Operating temperature:

ø 32 ... 100 mm
"Standard version"
-20 ... +80°C max. (-4 ... +176°F)
Air supply must be dry enough to avoid ice formation at temperatures below +2°C (+35°F).

Standard Materials:

Barrel: Anodised aluminium
End covers: Pressure diecast aluminium
Piston rod: Stainless steel (martensitic)
Piston rod seals: PUR
'O'-rings: NBR

Technical data

Cylinder ø (mm)	32	40	50	63	80	100
Profile barrel	•	•	•	•	•	•
Round barrel	•	•	•	•	•	•
Port size	G1/8	G1/4	G1/4	G3/8	G3/8	G1/2
Piston rod ø (mm)	12	16	20	20	25	25
Piston rod thread	M10x1,25	M12x1,25	M16x1,5	M16x1,5	M20x1,5	M20x1,5
Cushion length (mm)	20	22	24	24	26	33
Cushioning						
Adaptive cushioning systems "ACS"				•	•	•
Cushioning (adjustable cushion)	•	•	•			
Initial cushion volume (cm ³)	12,8	20,2	36	64	111	235
PRA/801000/M, PRA/801000M						
Theoretical thrusts at 6 bar outstroke (N)	392	648	1043	1735	2795	4492
F1 (N)	50	60	75	75	130	130
RA/803000/M, RA/803000M						
Theoretical thrusts at 6 bar instroke (N)	324	528	854	1546	2501	4197
F1 (N) *1)	50	60	75	75	130	130

F1 = Final retrun force of spring

The function

The new "ACS" Adaptive Cushioning System provides a high performance pneumatic damping function. The system will automatically cushion for a wide range of general applications as delivered. Manual adjustment is still possible for extreme applications.

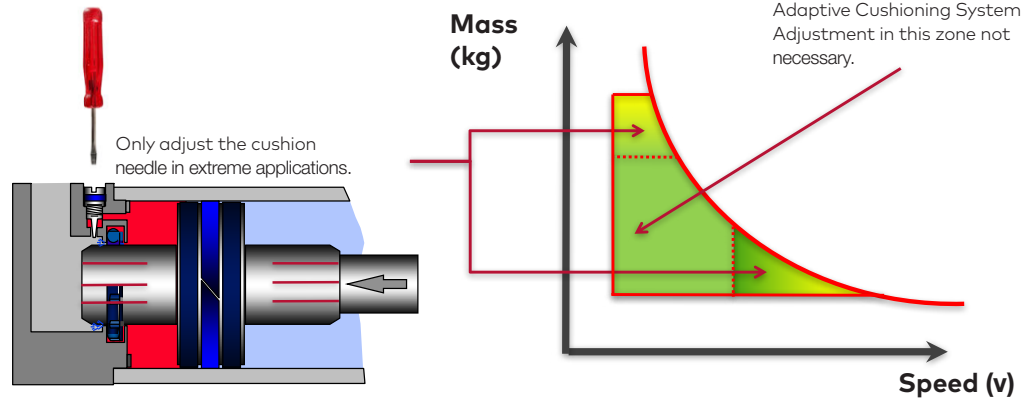

Design and sizing in pneumatics

Golden Rules

Design and sizing in pneumatics is often based upon experience coupled with an element of fear of under specifying crucial equipment. In an attempt to ensure enough power, engineers may select over sized cylinders and then select over sized valves to supply them with enough air. The same uncertainty can also lead to over sized specification of air line equipment, fittings and tubing. The outcome is components larger than necessary that use too much compressed air and waste energy and money. However when following some well proven golden rules and a few laws of pneumatics it is easy to achieve correctly sized pneumatic installations.

Basics to Consider



















The force required, the pressure available, the speed of movement and air consumption. ISO and VDMA standard or compact style also cushioning and sensors. Cylinders are greased on assembly and operate under normal conditions without additional lubrication. However using a lubricator will extend the life of these products.

Golden Rule:

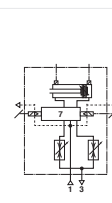
The theoretical force of the cylinder should be 25% extra for high speed, 50% extra for low speed and 100% extra for ultra low speed (positioning) applications.

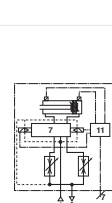
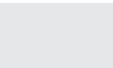
The correct sizing is based upon the required force and applied pressure. Go to page 1 for more information on cylinder sizing and air consumption.

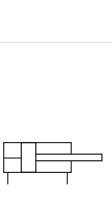
Additional ISO 15552 Cylinder ranges (Cylinder ranges in the red frame are shown in this data sheet.)

												
Symbols		Profile barrel Round Barrel	Industrial Automation	Food & Beverage	Automotive	ATEX II 2GD	Rail *)	CE-marked	ø (mm)	Range	Description	Datasheet
		•	•	•	•	•	•	•	32 ... 125	PRA/802000 LPRA/802000	Double Acting Cylinder	1.5_220_PRA_802000_M_RA_8000_M 1.5_225_PRA_802000_M_EX 1.5_220_LPRA_802000_M_LRA_8000_M
		•	•	•	•	•	•	•	32 ... 125	RA/802000 LPRA/802000	Double Acting Cylinder	1.5_220_PRA_802000_M_RA_8000_M 1.5_225_PRA_802000_M_EX 1.5_220_LPRA_802000_M_LRA_8000_M
		•	•	•	•	•	•	•	160 ... 320	RA/8000 LRA/8000	Double Acting Cylinder	1.5_220_PRA_802000_M_RA_8000_M 1.5_126_RA_8000_M_EX 1.5_220_LPRA_802000_M_LRA_8000_M
		•	•	•	•	•	•	•	32 ... 200	KA/802000	Stainless steel Cylinder	1.5_222_KA_802000_M 1.5_228_KA_802000_M_EX
		•	•	•	•	•	•	•	32 ... 100	PRA/822000	Smooth Line Cylinder	1.5_230_PRA_822000_M 1.5_235_PRA_822000_M_EX
		•	•	•	•	•	•	•	32 ... 100	PRA/842000	Clean Line Cylinder	1.5_240_PRA_842000_M 1.5_245_PRA_842000_M_EX
		•	•	•	•	•	•	•	32 ... 100	PRA/862000	IVAC Industrial Cylinder	1.5_250_PRA_862000_M 1.5_255_PRA_862000_M_EX
		•	•	•	•	•	•	•	32 ... 100	PRA/882000	IVAC Clean Line Cylinder	1.5_260_PRA_882000_M 1.5_265_PRA_882000_M_EX
		•	•	•	•	•	•	•	40 ... 125	PSA/182000/ F1	Cylinder with position sensor	1.9_051_PSA_182000_F1 1.9_052_PSA_182000_F1_EX
		•	•	•	•	•	•	•	160 ... 320	SA/8000/F1	Cylinder with position sensor	Datasheet (standard) 1.9_062_SA_8000_F1_EX
		•	•	•	•	•	•	•	32 ... 100	PRA/801000, PRA/803000	Standard Single Acting Cylinder	1.4_101_PRA_801000_803000 -
		•	•	•	•	•	•	•	32 ... 100	RA/801000, RA/803000	Standard Single Acting Cylinder	1.4_101_PRA_801000_803000 -

• Range available. For additional information please contact the technical service or <http://www.imi-precision.com>

*1) Rail Cylinder Shock and vibration tested to EN 61373 Category 1; Class A + B

Cylinder variants

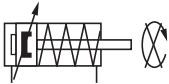
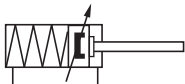
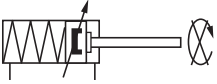







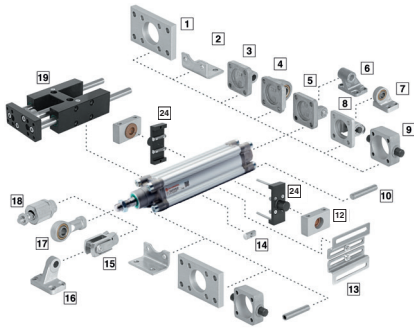
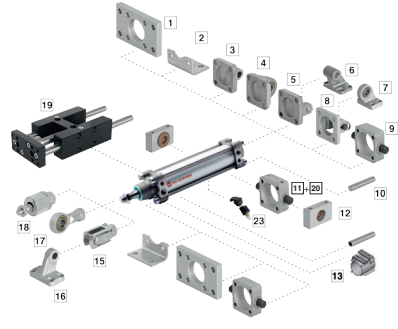

Symbol Please see the description below	Piston Rod Material				Standard Model with		ø (mm)	Description	Page
	R	S	C	D	Male Piston Rod Thread	Female Piston Rod Thread			
	X	•	•	•	PRA/801000/M	PRA/801000/MX	32... 100	Standard Cylinder Sprung in (Profile barrel)	8
	X	•	•	•	RA/801000/M	RA/801000/MX	32... 100	Standard Cylinder Sprung in (Round barrel)	8
	X				PRA/801000/N2	PRA/801000/N2X	32... 100	Cylinder with Non-Rotating Piston Rod Sprung in (Profile barrel) Maximum Stroke: 250 mm	10
	X				RA/801000/N2	RA/801000/N2X	32... 100	Cylinder with Non-Rotating Piston Rod Sprung in (Round barrel) Maximum Stroke: 250 mm	10
	X	•	•	•	PRA/803000/M	PRA/803000/MX	32... 100	Standard Cylinder Sprung out (Profile barrel)	11
	X	•	•	•	RA/803000/M	RA/803000/MX	32... 100	Standard Cylinder Sprung out (Round barrel)	11
	X	•	•	•	PRA/803000/MU	PRA/803000/MUX	32... 100	Cylinder with Extended Piston Rod Sprung out (Profile barrel) Maximum extension: 100 mm	11
	X	•	•	•	RA/803000/MU	RA/803000/MUX	32... 100	Cylinder with Extended Piston Rod Sprung out (Round barrel) Maximum extension: 100 mm	11
	X				PRA/803000/N2	PRA/803000/N2X	32... 100	Cylinder with Non-Rotating Piston Rod Sprung out (Profile barrel) Maximum Stroke: 250 mm	13
	X				RA/803000/N2	RA/803000/N2X	32... 100	Cylinder with Non-Rotating Piston Rod Sprung out (Round barrel) Maximum Stroke: 250 mm	13











Note: Piston Rod Material: C = Hard chromium plated; D = Stainless steel (austenitic) & hard chromium plated; R = Stainless steel (martensitic); S = Stainless steel (austenitic); X = Standard; • = Option

Option selector

Standard	Substitute	←	★★A/8★★★★/★★★/★★★	→	Strokes (mm)	Substitute
Round barrel	None				5 ... 250	
Profile barrel	P				Piston rod thread	Substitute
Piston rod material	Substitute	←			Male	None
Stainless steel (martensitic)	R				Female	X
Stainless steel (austenitic)	S				Note: If position ist not required, disregard option position within part number e.g. RA/801032/M/25. For combinations of cylinder variants consult our technical service. For example: Please note that heat resistant seals are not available for all variants. This option selector explains only the cylinder variants. Additional variants/options are not possible. Detail's see table on page 4.	
Hard chromium plated	C					
Stainless steel (austenitic) & hard chromium plated	D					
Cushioning	Substitute	←				
Sprung in (ø 32 ... 100 mm)	O1					
Sprung out (ø 32 ... 100 mm)	O3					
Cylinder ø (mm)	Substitute	←				
032, 040, 050, 063, 080, 100						
Variants ø 32 ... 100 mm (magnetic piston)	Substitute	←				
Standard	M					
Non-rotating piston rod (internal)	N2					
Extended piston rod	MU					
A/803*/MU/***/***/	Extension (mm)	→				

Cylinder with Profile barrel \varnothing 32 ... 100 mm

Cylinder with Round barrel \varnothing 32 ... 100 mm

Mountings

Model	A	AK	B, G	C	D	D2	F	FH	H	UH
\varnothing	 10 Page 14	 18 Page 14	 1 Page 14	 2 Page 14	 5 Page 15	 8 Page 15	 15 Page 15	 9 Page 15	 11 Page 16	 20 Page 16
32	QM/8032/35	QM/8025/38	QA/8032/22	QA/8032/21	QA/8032/23	QA/8032/42	QM/8025/25	QA/8032/34	QA/8032/28	QA/8032/40
40	QM/8032/35	QM/8040/38	QA/8040/22	QA/8040/21	QA/8040/23	QA/8040/42	QM/8040/25	QA/8040/34	QA/8040/28	QA/8040/40
50	QM/8050/35	QM/8050/38	QA/8050/22	QA/8050/21	QA/8050/23	QA/8050/42	QM/8050/25	QA/8050/34	QA/8050/28	QA/8050/40
63	QM/8050/35	QM/8050/38	QA/8063/22	QA/8063/21	QA/8063/23	QA/8063/42	QM/8050/25	QA/8063/34	QA/8063/28	QA/8063/40
80	QM/8080/35	QM/8080/38	QA/8080/22	QA/8080/21	QA/8080/23	QA/8080/42	QM/8080/25	QA/8080/34	QA/8080/28	QA/8080/40
100	QM/8080/35	QM/8080/38	QA/8100/22	QA/8100/21	QA/8100/23	QA/8100/42	QM/8080/25	QA/8100/34	QA/8100/28	QA/8100/40



\varnothing	UH	S	SW	UF	UR	R	SS	US	Groove key	Valve mounting kit
	 24 Page 16	 12 Page 16	 6 Page 17	 17 Page 17	 4 Page 17	 3 Page 17	 16 Page 18	 7 Page 18	 14 Page 18	 13 Page 26 & 27
32	PQA/802032/40	QA/8032/41	M/P19493	QM/8025/32	QA/8032/33	QA/8032/27	M/P19931	M/P40310	M/P72816	More Details see page 26 & 27
40	PQA/802040/40	QA/8040/41	M/P19494	QM/8040/32	QA/8040/33	QA/8040/27	M/P19932	M/P40311	M/P72816	
50	PQA/802050/40	QA/8040/41	M/P19495	QM/8050/32	QA/8050/33	QA/8050/27	M/P19933	M/P40312	M/P72816	
63	PQA/802063/40	QA/8063/41	M/P19496	QM/8050/32	QA/8063/33	QA/8063/27	M/P19934	M/P40313	M/P72816	
80	PQA/802080/40	QA/8063/41	M/P19497	QM/8080/32	QA/8080/33	QA/8080/27	M/P19935	M/P40314	M/P72816	
100	PQA/802100/40	QA/8100/41	M/P19498	QM/8080/32	QA/8100/33	QA/8100/27	M/P19936	M/P40315	M/P72816	

Pos.	Style	Standard
1	B, G	Clear anodised aluminium
2	C	Galvanized steel (\varnothing 32 ... 100 mm)
3	R	Die-cast aluminium
4	UR	Galvanized aluminium Inner ring: steel Outer ring: brass
5	D	Die-cast aluminium Bolt: galvanized steel (martensitic) Circlip: galvanized steel
6	SW	Die-cast aluminium
7	US	Galvanized aluminium Inner ring: steel Outer ring: brass

Pos.	Style	Standard
8	D2	Painted cast iron Bolt: stainless steel (martensitic) Circlip: galvanized steel
9	FH	Cast iron
10	A	Galvanized steel
11	H	Cast iron
12	S	Clear anodised aluminium Bearing: brass
13	Valve mounting kit	Galvanized steel
14	Groove key	Steel

Pos.	Style	Standard
15	F	Galvanized steel Bolt: galvanized steel Circlip: Galvanized steel
16	SS	Painted cast iron
17	UF	Galvanized steel, Inner ring: steel Outer ring: brass
18	AK	Galvanized steel
20	UH	Cast iron
24	UH	Anodised aluminium

Accessories for Profile (ø 32 ... 100 mm) & Round barrel (ø 32 ... 100 mm)







Model Profile barrel	Model Round barrel	ø	Port size	Banjo flow control	Straight fitting	Elbow fitting
						
PRA/80*032/M/*	RA/80*032/M/*	32	G1/8	COK510618	C02250618	C02470618
PRA/80*040/M/*	RA/80*040/M/*	40	G1/4	COK510628	C02250628	C02470628
PRA/80*050/M/*	RA/80*050/M/*	50	G1/4	COK510828	C02250828	C02470828
PRA/80*063/M/*	RA/80*063/M/*	63	G3/8	COK510838	C02250838	C02470838
PRA/80*080/M/*	RA/80*080/M/*	80	G3/8	COK511038	C02251038	C02471038
PRA/80*100/M/*	RA/80*100/M/*	100	G1/2	COK511248	C02251248	C02471248

For alternative fitting types please contact the technical service.

Service kit

Service kit for Round and Profile barrel	
ø	
	
32	QA/8032/00
40	QA/8040/00
50	QA/8050/00
63	QA/8063/00
80	QA/8080/00
100	QA/8100/00

Magnetically operated switches

ø	M/50/**  Page 19 - 22	Groove cover  Page 18	Switch mounting brackets for M/50  Page 22	TQM/31, QM/32, QM/132  Page 23	Switch mounting brackets for TQM/31, QM/32, QM/132  Page 24	QM/140  Page 25	Switch mounting brackets for QM/140  Page 26
32		M/P72725/1000	QM/27/2/1		QM/31/032/22		QM/140/010/22
40		M/P72725/1000	QM/27/2/1		QM/31/032/22		QM/140/010/22
50		M/P72725/1000	QM/27/2/1		QM/31/032/22		QM/140/010/22
63		M/P72725/1000	QM/27/2/1		QM/31/032/22		QM/140/010/22
80		M/P72725/1000	QM/27/2/1		QM/31/080/22		QM/140/010/22
100		M/P72725/1000	QM/27/2/1		QM/31/080/22		QM/140/010/22

Basic dimensions
PRA/801000/M, RA/801000/M
Standard Cylinder Sprung in

Dimensions in mm
 Projection/First angle

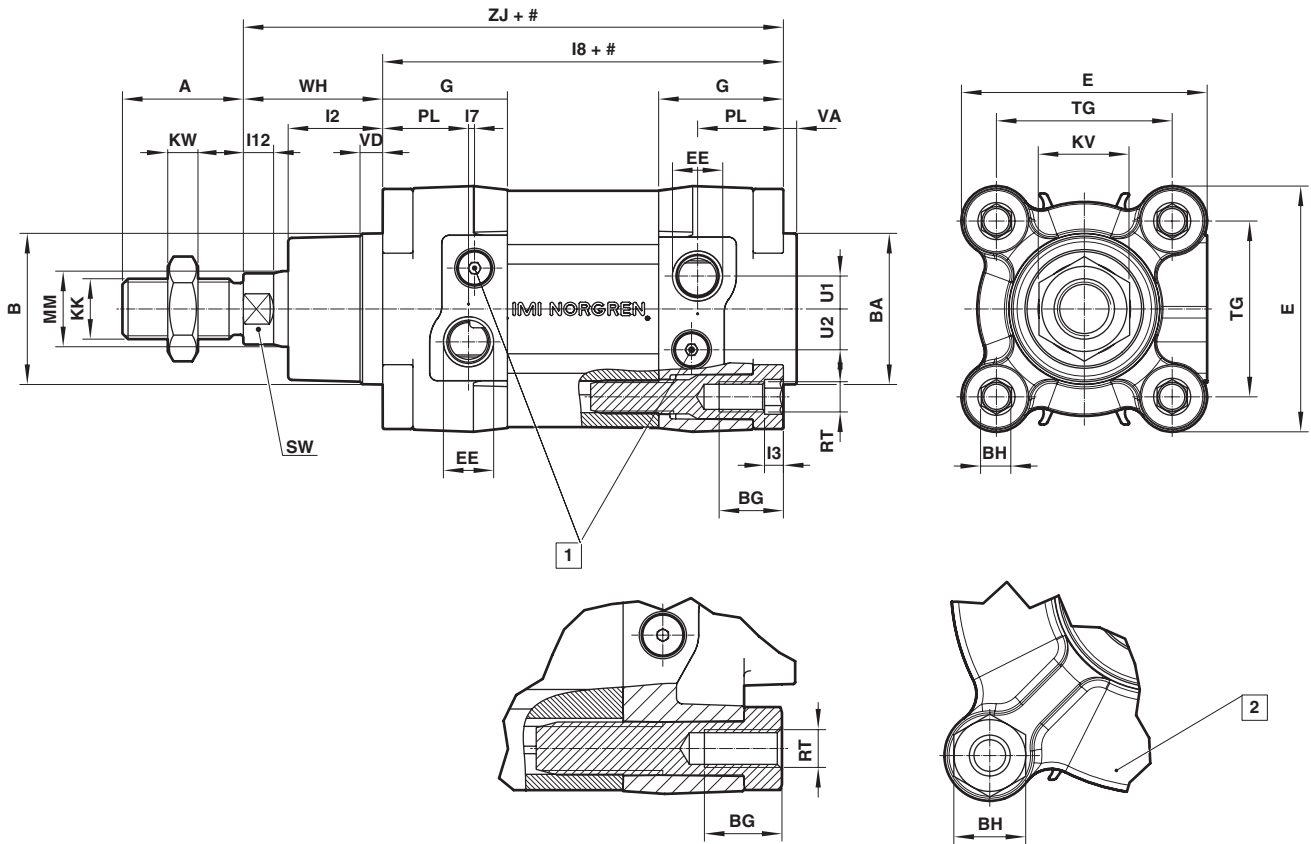

Model Profile barrel
 ø 32 ... 100 mm

Model Round barrel
 ø 32 ... 100 mm

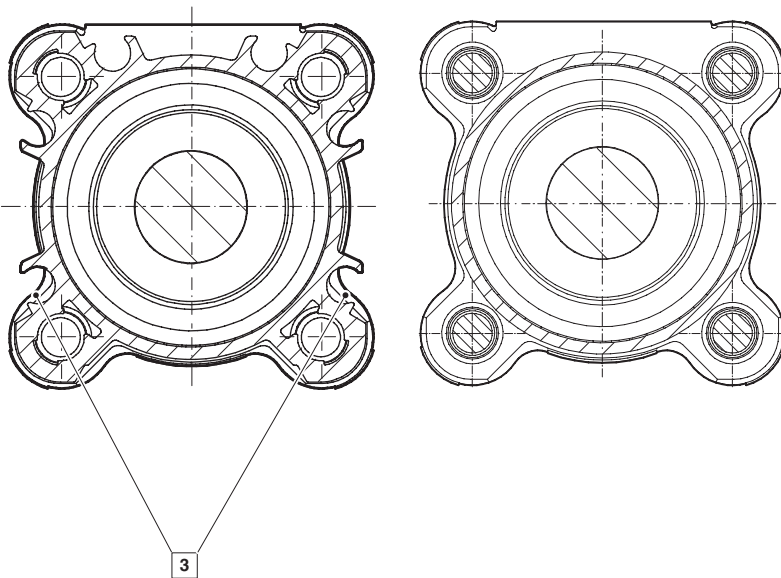

- # Stroke
 - 1 Cushion screw
 - 2 ø 80 ... 100 mm
 - 3 M/50 switches can be mounted flush with the profile
- For additional information please contact the technical service or <http://www.imi-precision.com>

∅	A -0,5	∅ B d11	∅ BA d11	BG min	BH	E	EE	G	KK	KV	KW	L2	L3	L7	L8	L12	∅ MM h9	PL	TG
32	22	30	30	16	6	47	G1/8	29	M10x1,25	17	5	19,5	4	6,6	119 + (N *28)	5,5	12	15	32,5
40	24	35	35	16	6	53	G1/4	34,5	M12x1,25	19	6	22	4	5,6	130 + (N *28)	6,5	16	21,5	38
50	32	40	40	16	8	65	G1/4	33	M16x1,5	24	8	25	5	1,6	131 + (N *28)	8	20	22,7	46,5
63	32	45	45	16	8	75	G3/8	36,5	M16x1,5	24	8	25	5	3,6	146 + (N *28)	8	20	24,2	56,5
80	40	45	45	17	19	95	G3/8	42	M20x1,5	30	10	33	-	1,8	153 + (N *28)	10	25	29,7	72
100	40	55	55	17	19	113	G1/2	42	M20x1,5	30	10	35	-	3,8	163 + (N *28)	10	25	27,7	89

∅	RT	SW	U1	U2	VA	VD	WH	ZJ	Model Profile barrel	at 0 mm	per 25 mm	Model Round barrel	at 0 mm	per 25 mm
32	M6	10	4,6	6,3	3,5	6	26	145 + (N *28)	PRA/801032/M/*	0,49 (kg)	0,15 (kg)	RA/801032/M/*	0,46 (kg)	0,16 (kg)
40	M6	13	5,8	9,2	3,5	6	30	160 + (N *28)	PRA/801040/M/*	0,69 (kg)	0,22 (kg)	RA/801040/M/*	0,65 (kg)	0,21 (kg)
50	M8	17	8,7	10,8	3,5	6	37	168 + (N *28)	PRA/801050/M/*	1,09 (kg)	0,31 (kg)	RA/801050/M/*	1,02 (kg)	0,32 (kg)
63	M8	17	10	12,8	3,5	6	37	183 + (N *28)	PRA/801063/M/*	1,54 (kg)	0,35 (kg)	RA/801063/M/*	1,46 (kg)	0,36 (kg)
80	M10	22	12	14,5	3,5	6	46	199 + (N *28)	PRA/801080/M/*	2,64 (kg)	0,62 (kg)	RA/801080/M/*	2,54 (kg)	0,64 (kg)
100	M10	22	9	14,5	3,5	6	51	214 + (N *28)	PRA/801100/M/*	3,66 (kg)	0,72 (kg)	RA/801100/M/*	3,50 (kg)	0,73 (kg)

* Please insert stroke length; Basic Dimension are also for cylinder variants or for different piston rod material

Hub (stroke)	RT	Note
<= 50	N = 0	
> 50	N = $\frac{\text{Hub (stroke)}}{50}$	-1 round up to integer

Cylinder variants
PRA/801000/MX, RA/801000/MX
Cylinder with Female Piston Rod Thread Sprung in

Dimensions in mm
 Projection/First angle

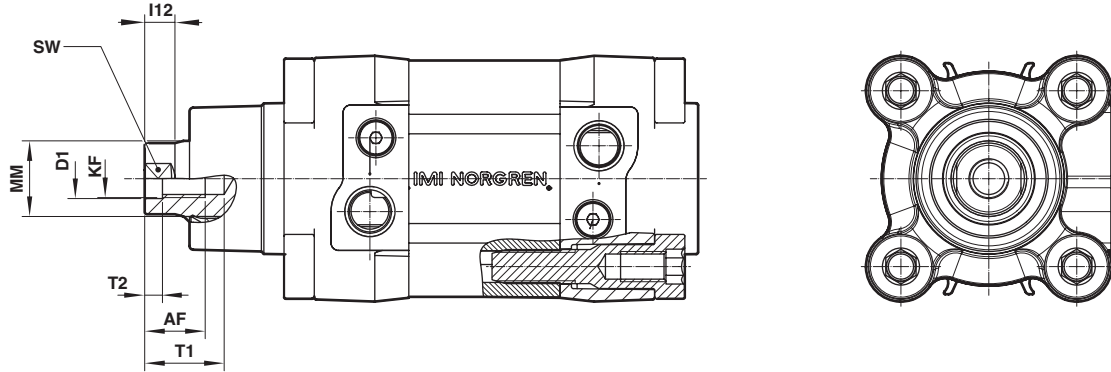

ø	AF	ø D1	KF	I12	ø MM h9	SW	T1	T2
32	12	6,4	M6	5,5	12	10	16	2,6
40	12	8,4	M8	6,5	16	13	16	3,3
50	16	10,5	M10	8	20	17	21	4,7
63	16	10,5	M10	8	20	17	21	4,7
80	20	13	M12	10	25	22	25	6,1
100	20	13	M12	10	25	22	25	6,1

For missing dimensions please see page 8 and 9

Cylinder variants
PRA/801000/N2, RA/801000/N2 – Cylinder with Non-Rotating Piston Rod Sprung in
PRA/801000/N2X, RA/801000/N2X – Cylinder with Non-Rotating Piston Rod and Female Piston Rod Thread Sprung in

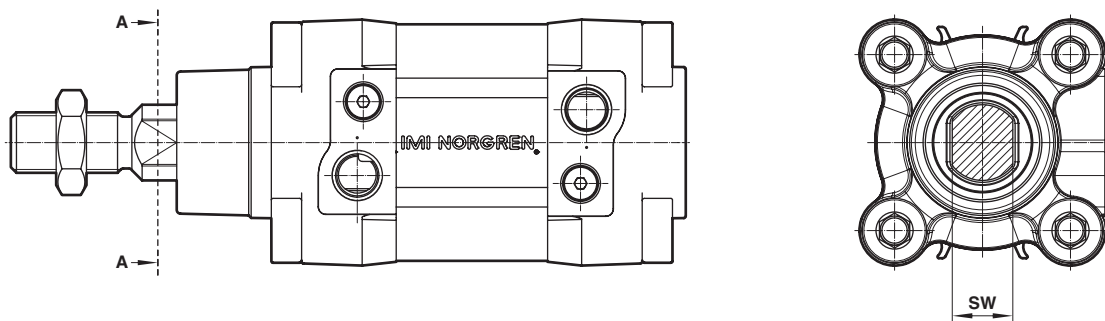

ø	SW	max. Torque (Nm)	Model Profile barrel	Model Round barrel
32	10	0,5	PRA/801032/N2/*	RA/801032/N2/*
40	13	1	PRA/801040/N2/*	RA/801040/N2/*
50	16	1,5	PRA/801050/N2/*	RA/801050/N2/*
63	16	1,5	PRA/801063/N2/*	RA/801063/N2/*
80	21	2,5	PRA/801080/N2/*	RA/801080/N2/*
100	21	2,5	PRA/801100/N2/*	RA/801100/N2/*

* Please insert stroke length; Maximum Hub: 250 mm; For missing dimensions please see page 8 and 9

Basic dimensions
PRA/803000/M, RA/803000/M, PRA/803000/MU, RA/803000/MU
Standard Cylinder Sprung out

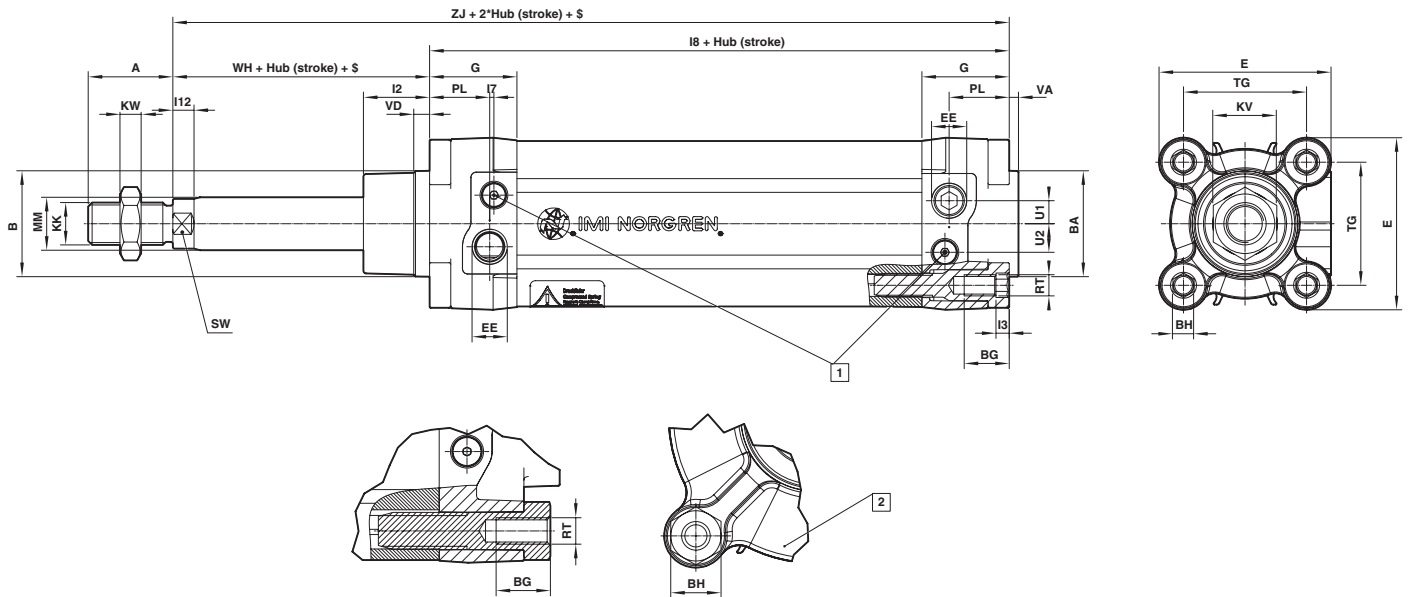
 Dimensions in mm
 Projection/First angle

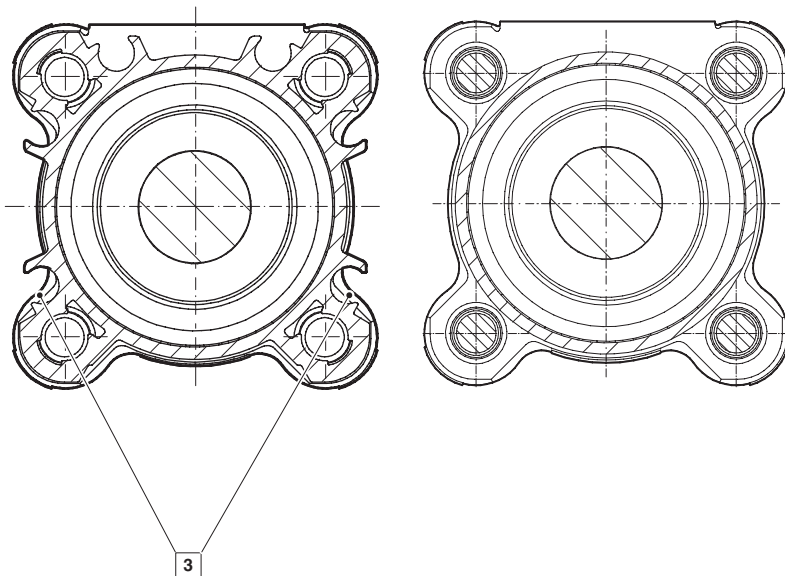
Model Profile barrel
 ø 32 ... 100 mm

Model Round barrel
 ø 32 ... 100 mm

Stroke

\$ Piston rod extension

1 Cushion screw

2 ø 80 ... 100 mm

3 M/50 switches can be mounted flush with the profile

 For additional information please contact the technical service or <http://www.imi-precision.com>

ø	A -0,5	ø B d11	ø BA d11	BG min	BH	E	EE	G	KK	KV	KW	L2	L3	L7	L8	L12	ø MM h9	PL	TG
32	22	30	30	16	6	47	G1/8	29	M10x1,25	17	5	19,5	4	6,6	119 + (N *28)	5,5	12	15	32,5
40	24	35	35	16	6	53	G1/4	34,5	M12x1,25	19	6	22	4	5,6	130 + (N *28)	6,5	16	21,5	38
50	32	40	40	16	8	65	G1/4	33	M16x1,5	24	8	25	5	1,6	131 + (N *28)	8	20	22,7	46,5
63	32	45	45	16	8	75	G3/8	36,5	M16x1,5	24	8	25	5	3,6	146 + (N *28)	8	20	24,2	56,5
80	40	45	45	17	19	95	G3/8	42	M20x1,5	30	10	33	-	1,8	153 + (N *28)	10	25	29,7	72
100	40	55	55	17	19	113	G1/2	42	M20x1,5	30	10	35	-	3,8	163 + (N *28)	10	25	27,7	89

ø	RT	SW	U1	U2	VA	VD	WH	ZJ	Model Profile barrel	at 0 mm	per 25 mm	Model Round barrel	at 0 mm	per 25 mm
32	M6	10	4,6	6,3	3,5	6	26	145 + (N *28)	PRA/803032/M/*	0,49 (kg)	0,13 (kg)	RA/803032/M/*	0,46 (kg)	0,13 (kg)
40	M6	13	5,8	9,2	3,5	6	30	160 + (N *28)	PRA/803040/M/*	0,69 (kg)	0,17 (kg)	RA/803040/M/*	0,65 (kg)	0,17 (kg)
50	M8	17	8,7	10,8	3,5	6	37	168 + (N *28)	PRA/803050/M/*	1,09 (kg)	0,24 (kg)	RA/803050/M/*	1,02 (kg)	0,25 (kg)
63	M8	17	10	12,8	3,5	6	37	183 + (N *28)	PRA/803063/M/*	1,54 (kg)	0,28 (kg)	RA/803063/M/*	1,46 (kg)	0,29 (kg)
80	M10	22	12	14,5	3,5	6	46	199 + (N *28)	PRA/803080/M/*	2,64 (kg)	0,51 (kg)	RA/803080/M/*	2,54 (kg)	0,53 (kg)
100	M10	22	9	14,5	3,5	6	51	214 + (N *28)	PRA/803100/M/*	3,66 (kg)	0,61 (kg)	RA/803100/M/*	3,50 (kg)	0,62 (kg)

* Please insert stroke length.

Basic Dimension are also for cylinder variants or for different piston rod material

Hub (stroke)	RT	Note
<= 50	N = 0	
> 50	N = $\frac{\text{Hub (stroke)}}{50} - 1$	round up to integer

Cylinder variants
PRA/803000/MX, RA/803000/MX, PRA/803000/MUX, RA/803000/MUX
Cylinder with Female Piston Rod Thread Sprung out

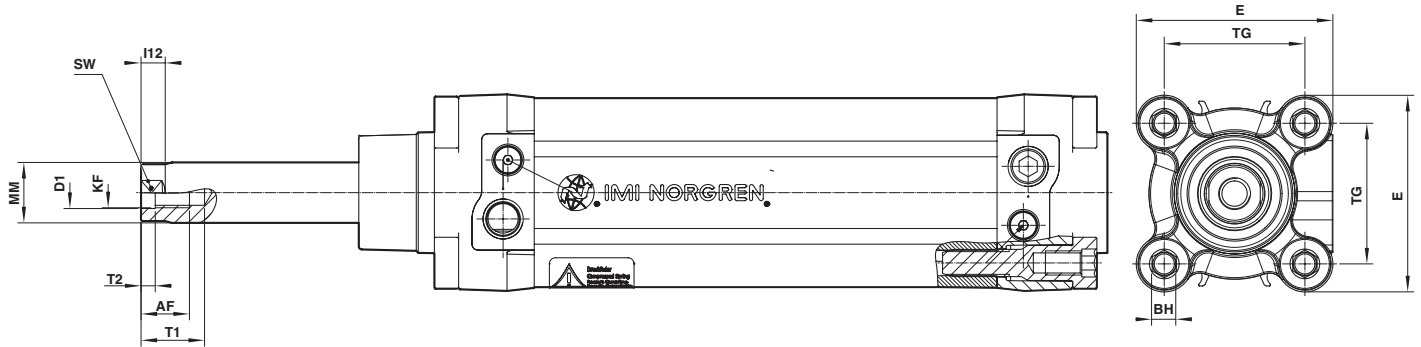
 Dimensions in mm
 Projection/First angle

ø	AF	ø D1	KF	I12	ø MM h9	SW	T1	T2
32	12	6,4	M6	5,5	12	10	16	2,6
40	12	8,4	M8	6,5	16	13	16	3,3
50	16	10,5	M10	8	20	17	21	4,7
63	16	10,5	M10	8	20	17	21	4,7
80	20	13	M12	10	25	22	25	6,1
100	20	13	M12	10	25	22	25	6,1

For missing dimensions please see page 8 and 9

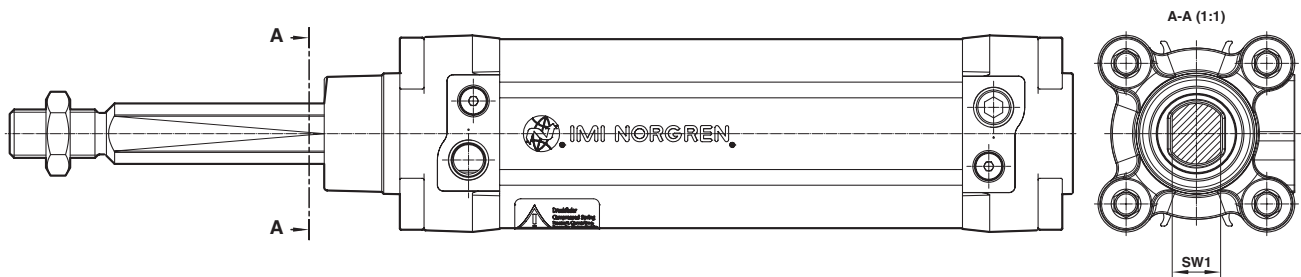
Cylinder variants
PRA/803000/N2, RA/803000/N2 – Cylinder with Non-Rotating Piston Rod Sprung out
PRA/803000/N2X, RA/803000/N2X – Cylinder with Non-Rotating Piston Rod and Female Piston Rod Thread Sprung out

ø	SW	max. Torque (Nm)	Model Profile barrel	Model Round barrel
32	10	0,5	PRA/803032/N2/*	RA/803032/N2/*
40	13	1	PRA/803040/N2/*	RA/803040/N2/*
50	16	1,5	PRA/803050/N2/*	RA/803050/N2/*
63	16	1,5	PRA/803063/N2/*	RA/803063/N2/*
80	21	2,5	PRA/803080/N2/*	RA/803080/N2/*
100	21	2,5	PRA/803100/N2/*	RA/803100/N2/*

* Please insert stroke length; Maximum stroke: 250 mm; For missing dimensions please see page 8 and 9

Mountings

Front or rear stud mounting A

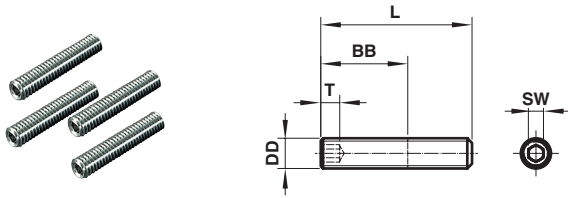

ø	BB	DD	L	SW	T (min)	(kg)	Model (A)
32/40	17	M6	30	3	3,5	0,02	QM/8032/35
50/63	23	M8	40	4	5	0,05	QM/8050/35
80/100	28	M10	45	5	6	0,08	QM/8080/35

Piston rod swivel AK

Dimensions in mm
Projection/First angle

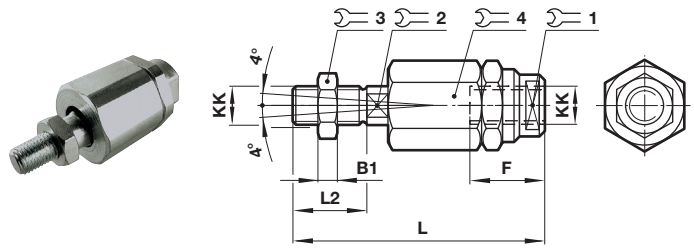

ø	KK	B1	F	L	L2	SW				(kg)	Model (AK)
						1	2	3	4		
32	M10x1,25	5	26	73	20	19	12	17	30	0,20	QM/8025/38
40	M12x1,25	6	26	77	24	19	12	19	30	0,20	QM/8040/38
50/63	M16x1,5	8	34	106	32	30	19	24	42	0,65	QM/8050/38
80/100	M20x1,5	10	42	122	40	30	19	30	42	0,72	QM/8080/38

Front flange B, G

Conforms to ISO 15552,
type MF1 and MF2

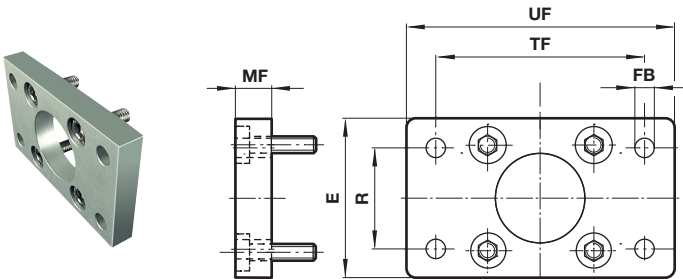

ø	E	ø FB	MF	R	TF	UF	(kg)	Model (B, G)
32	50	7	10	32	64	80	0,10	QA/8032/22
40	55	9	10	36	72	90	0,12	QA/8040/22
50	65	9	12	45	90	110	0,21	QA/8050/22
63	75	9	12	50	100	125	0,27	QA/8063/22
80	100	12	16	63	126	154	0,63	QA/8080/22
100	120	14	16	75	150	186	0,89	QA/8100/22

Foot mounting C

Conforms to ISO 15552, type MS1

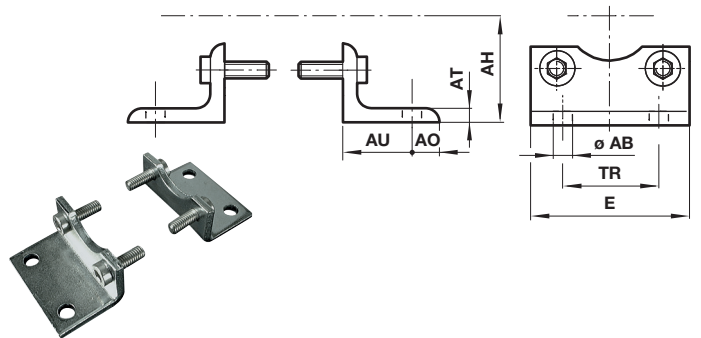

ø	ø AB	AH	AO	AT	AU	E	TR	(kg)	Model (C)
32	7	32	8	4	24	48	32	0,15	QA/8032/21
40	10	36	9	4	28	53	36	0,18	QA/8040/21
50	10	45	10	5	32	64	45	0,30	QA/8050/21
63	10	50	12	5	32	74	50	0,39	QA/8063/21
80	12	63	19	6	41	98	63	0,80	QA/8080/21
100	14,5	71	19	6	41	115	75	0,95	QA/8100/21

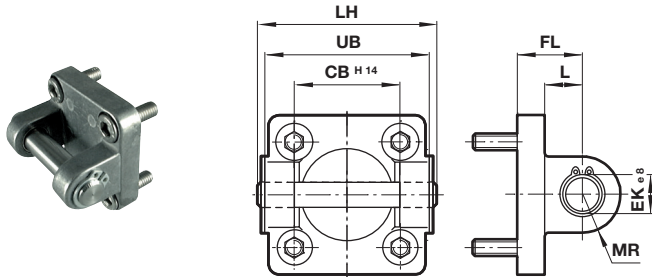
Rear clevis D
Conforms to ISO 15552, type MP2

∅	CB H14	∅ EKe8	FL	L	LH	MR	UB	(kg)	Model (D)
32	26	10	22	13	52	9	45	0,11	QA/8032/23
40	28	12	25	16	60	12	52	0,16	QA/8040/23
50	32	12	27	17	68	12	60	0,22	QA/8050/23
63	40	16	32	22	79	15	70	0,34	QA/8063/23
80	50	16	36	22	99	15	90	0,54	QA/8080/23
100	60	20	41	27	119	20	110	0,90	QA/8100/23

Rear clevis D2
Conforms to ISO 15552, type AB6

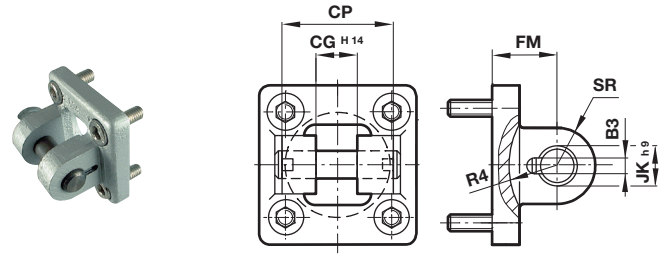
 Dimensions in mm
 Projection/First angle

∅	CGH14	CP	B3	∅ JK h9	FM	SR	R4	(kg)	Model (D2)
32	14	34	3,3	10	22	11	17	0,20	QA/8032/42
40	16	40	4,3	12	25	12	20	0,23	QA/8040/42
50	21	45	4,3	16	27	14,5	22	0,36	QA/8050/42
63	21	51	4,3	16	32	18	25	0,55	QA/8063/42
80	25	65	4,3	20	36	22	30	0,90	QA/8080/42
100	25	75	4,3	20	41	22	32	1,45	QA/8100/42

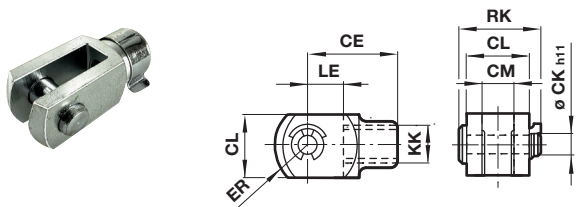
Piston rod clevis F
Conforms to DIN ISO 8140

∅	KK	CE	∅ CK h11	CL	CM	ER	LE	RK	(kg)	Model (F)
32	M10x1,25	40	10	20	10	16	20	27,5	0,09	QM/8025/25
40	M12x1,25	48	12	24	12	19	24	33,5	0,13	QM/8040/25
50/63	M16x1,5	64	16	32	16	25	32	42	0,33	QM/8050/25
80/100	M20x1,5	80	20	40	20	32	40	51	0,67	QM/8080/25

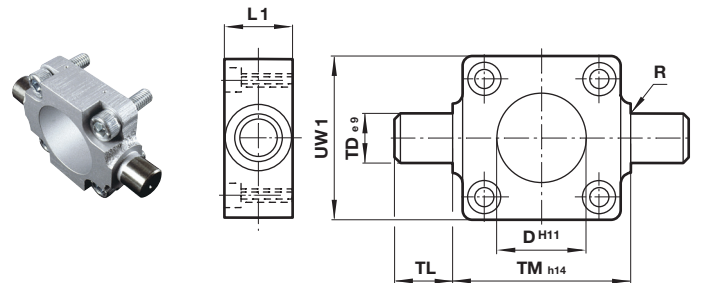
Front or rear detachable trunnion FH
Conforms to VDMA 24562 part 2, type MT 5/6

∅	∅ D H11	L1	R	∅ TDe9	TL	TM h14	UW1	(kg)	Model (FH)
32	30	16	1	12	12	50	45	0,20	QA/8032/34
40	35	20	1,6	16	16	63	55	0,38	QA/8040/34
50	40	24	1,6	16	16	75	65	0,60	QA/8050/34
63	45	24	1,6	20	20	90	75	1,10	QA/8063/34
80	45	28	1,6	20	20	110	100	1,90	QA/8080/34
100	55	38	2	25	25	132	120	3,50	QA/8100/34

Centre trunnion – H
Conforms to ISO 15552, type MT4
Used for cylinder model with round barrel

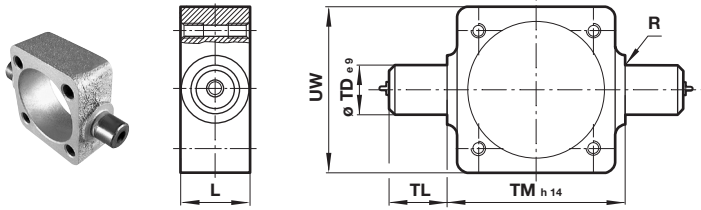

ø	L	R	øTD e9	TL	TM h14	UW	XV min.	XV max. + #	(kg)	Model (H)
32	20	1	12	12	50	50	66	80	0,16	QA/8032/28
40	24	1,6	16	16	63	58	76	89	0,35	QA/8040/28
50	28	1,6	16	16	75	70	82	98	0,65	QA/8050/28
63	28	1,6	20	20	90	80	88	107	0,85	QA/8063/28
80	28	1,6	20	20	110	100	97	123	1,2	QA/8080/28
100	38	2	25	25	132	126	107	128	2,3	QA/8100/28

Note: Style 'H': These mountings are only supplied assembled complete with the cylinder. Unless otherwise specified, units will be supplied with dimension 'XV min', plus half the stroke length. 'XV' = Distance from the piston rod shoulder to the centre of the mounting (Please see drawing).

Not for use on profile options.
 This item is suited to all loads including heavy duty loads.
 This item is for replacement only
 H mounting must be initially ordered with the cylinder.

Adjustable trunnion mounting UH
Conforms to ISO 15552, type MT4
Used for cylinder model with round barrel

Dimensions in mm
 Projection/First angle

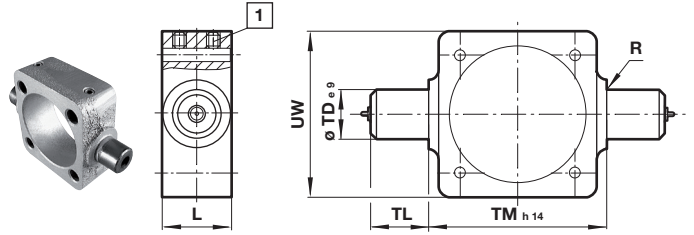

1 Locking screws
 Torque max: ø 32 & 40 mm = 6 Nm; ø 50 & 63 mm = 10 Nm;
 ø 80 & 100 mm = 15 Nm

ø	L	R	øTD e9	TL	TM h14	UW	XV min.	XV max. + #	(kg)	Model (UH)
32	20	1	12	12	50	50	65	81	0,16	QA/8032/40
40	24	1,6	16	16	63	58	76,5	88,5	0,35	QA/8040/40
50	28	1,6	16	16	75	70	84	96	0,65	QA/8050/40
63	28	1,6	20	20	90	80	87,5	107,5	0,85	QA/8063/40
80	28	1,6	20	20	110	100	102	118	1,2	QA/8080/40
100	38	2	25	25	132	126	112	128	2,3	QA/8100/40

Style 'UH': It is most important that the locking screws which secure the mounting to the tie rod are tightened to the torque figures shown in the table below.

For maximum energy input, consult our Technical Service.

Unless otherwise specified, units will be supplied with dimension 'XV min' plus half the stroke length. 'XV' = Distance from the piston rod shoulder to the centre of the mounting (Please see drawing).

Not for use on profile options.
 This item is adjustable and suited to normal loads.

Adjustable trunnion mounting UH
Conforms to ISO 15552, type MT4
Used for cylinder model with profile barrel

Stroke

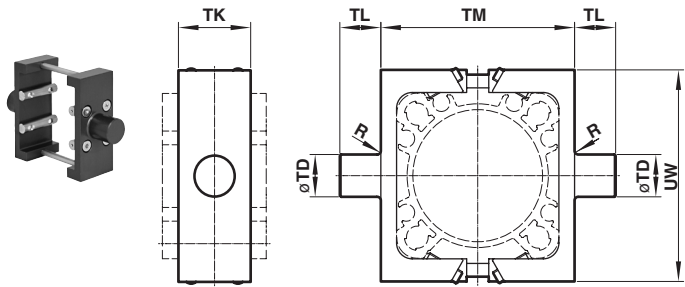

ø	R	øTD e9	TK max.	TL h14	TM h14	UW	XV min.	XV max. + #	(kg)	Torque (Nm)	Model (UH)
32	1	12	25	12	50	58	67,5	78,5	0,06	1,3	PQA/802032/40
40	1,6	16	28	16	63	65	78,5	86,5	0,11	1,3	PQA/802040/40
50	1,6	16	28	16	75	80	84	96	0,16	4	PQA/802050/40
63	1,6	20	36	20	90	96	91,5	103,5	0,32	4	PQA/802063/40
80	1,6	20	36	20	110	116	106	114	0,37	6,5	PQA/802080/40
100	2	25	48	25	132	140	117	123	0,72	6,5	PQA/802100/40

Style 'UH': It is most important that the locking screws which secure the mounting to the tie rod are tightened to the torque figures shown in the table below.

For maximum energy input, consult our Technical Service.

Unless otherwise specified, units will be supplied with dimension 'XV min', plus half the stroke length. 'XV' = Distance from the piston rod shoulder to the centre of the mounting (Please see drawing).
 This item is adjustable and suited to normal loads.

Trunnion support S
Conforms to ISO 15552, type AT4

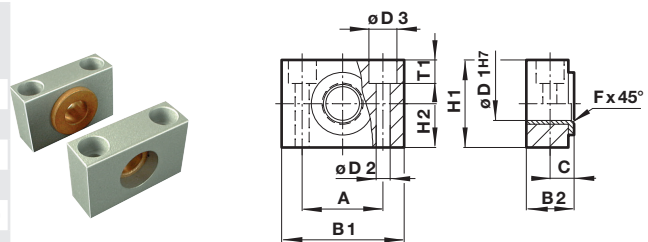

ø	A	B	C	ø	ø	ø	Fx 45°	H	H	T1	(kg)	Model (S)	
	1	2		D1H7	D2	D3		1	2				
32	32	46	18	10,5	12	6,6	11	1	30	15	6,8	0,10	QA/8032/41
40/50	36	55	21	12	16	9	15	1,6	36	18	9	0,14	QA/8040/41
63/80	42	65	23	13	20	11	18	1,6	40	20	11	0,18	QA/8063/41
100	50	75	28,5	16,5	25	14	20	2	50	25	13	0,34	QA/8100/41

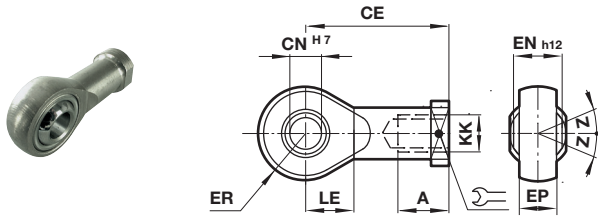
Universal piston rod eye UF
 Conforms to DIN ISO 8139

ø	Thread KK	A	CE	ø CNH7	EN h12	ER	LE	Z	(kg)	Model (UF)
32	M10x1,25	20	43	10	14	14	15	9°	0,09	QM/8025/32
40	M12x1,25	22	50	12	16	16	17	13°	0,13	QM/8040/32
50/63	M16x1,5	28	64	16	21	21	22	15°	0,33	QM/8050/32
80/100	M20x1,5	33	77	20	25	25	26	15°	0,67	QM/8080/32

Universal rear eye UR
 Conforms to ISO 15552, type MP6

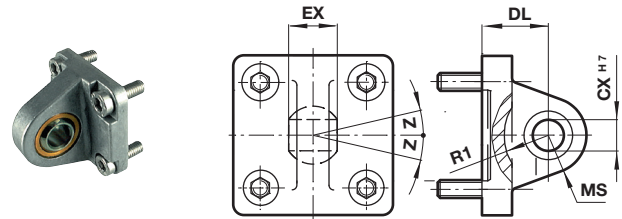
 Dimensions in mm
 Projection/First angle

ø	ø CX H7	EX	MS	DL	R1	Z	(kg)	Model (UR)
32	10	14	16	22	13	13°	0,15	QA/8032/33
40	12	16	18	25	16	13°	0,25	QA/8040/33
50	16	21	21	27	19	15°	0,40	QA/8050/33
63	16	21	23	32	22	15°	0,55	QA/8063/33
80	20	25	28	36	24	14°	0,90	QA/8080/33
100	20	25	30	41	27	14°	1,50	QA/8100/33

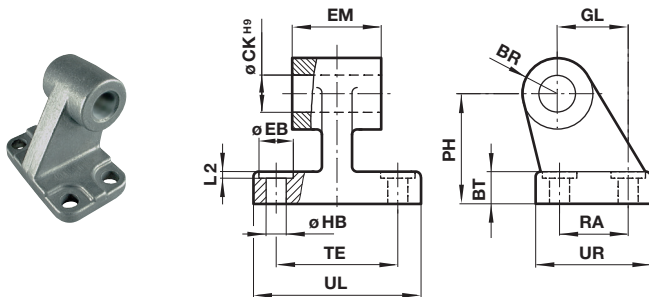
Wide hinge SW
 Conforms to ISO 15552, type AB7

ø	BR	BT	PH	ø CKH9	ø EB	EM	GL
32	10	7	32	10	12	25,6	21
40	11	9	36	12	12	37,6	24
50	13	11	45	12	15	31,6	33
63	15	11	50	16	15	39,6	37
80	15	14	63	16	18	49,6	47
100	18	15	71	20	18	59,6	55

ø	ø HB	L2	RA	TE	UL	UR	(kg)	Model (SW)
32	6,6	1,6	18	38	50	31	0,05	M/P19493
40	6,6	1,6	22	41	53	35	0,07	M/P19494
50	9	1,6	30	50	65	45	0,14	M/P19495
63	9	1,6	35	52	67	50	0,18	M/P19496
80	11	2,5	40	66	84	60	0,28	M/P19497
100	11	2,5	50	76	94	70	0,42	M/P19498

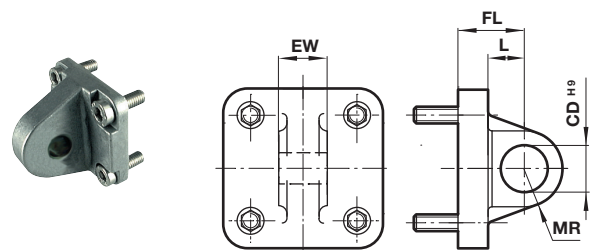
Rear eye R
 Conforms to ISO 15552, type MP4

ø	ø CDH9	EW	FL	L	MR	(kg)	Model (R)
32	10	25,6	22	13	9	0,09	QA/8032/27
40	12	27,6	25	16	12	0,11	QA/8040/27
50	12	31,6	27	17	12	0,17	QA/8050/27
63	16	39,6	32	22	15	0,24	QA/8063/27
80	16	49,6	36	22	15	0,37	QA/8080/27
100	20	59,6	41	27	20	0,59	QA/8100/27

Narrow hinge SS

Dimensions in mm
Projection/First angle

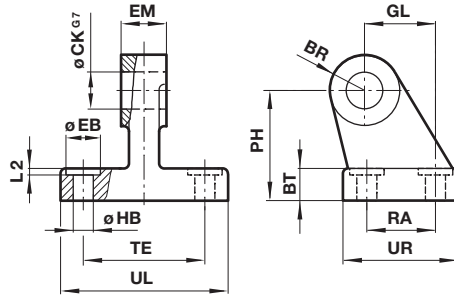

ø	BR	BT	ø CK G7	ø EB	EM	GL	ø HB	L2	PH	RA	TE	UL	UR	(kg)	Model (SS)
32	10	8	10	11	10	21	6,6	1,6	32	18	38	51	31	0,15	M/P19931
40	11	10	12	11	12	24	6,6	1,6	36	22	41	54	35	0,20	M/P19932
50	13	12	16	15	16	33	9	1,6	45	30	50	65	45	0,48	M/P19933
63	15	12	16	15	16	37	9	1,6	50	35	52	67	50	0,50	M/P19934
80	15	14	20	18	20	47	11	2,5	63	40	66	86	60	0,75	M/P19935
100	19	15	20	18	20	55	11	2,5	71	50	76	96	70	1,20	M/P19936

Swivel hinge US Conforms to VDMA 24562 part 2

Groove key M/P72816 Weight: 0,01 (kg)

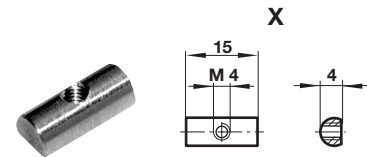
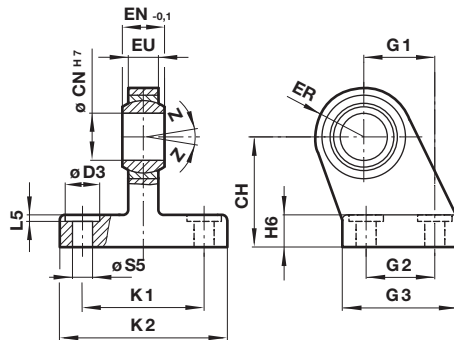

ø	CH	ø CN H7	ø D3	EN-0,1	ER	EU	G1	G2	G3	H6	K1	K2	L5	S5	Z	(kg)	Model (US)
32	32	10	11	14	16	10,5	21	18	31	10	38	51	1,6	6,6	13°	0,19	M/P40310
40	36	12	11	16	18	12	24	22	35	10	41	54	1,6	6,6	13°	0,24	M/P40311
50	45	16	15	21	21	15	33	30	45	12	50	65	1,6	9	15°	0,46	M/P40312
63	50	16	15	21	23	15	37	35	50	12	52	67	1,6	9	15°	0,59	M/P40313
80	63	20	18	25	28	18	47	40	60	14	66	86	2,5	11	14°	1,03	M/P40314
100	71	20	18	25	30	18	55	50	70	15	76	96	2,5	11	14°	1,40	M/P40315

Groove cover M/P72725/1000

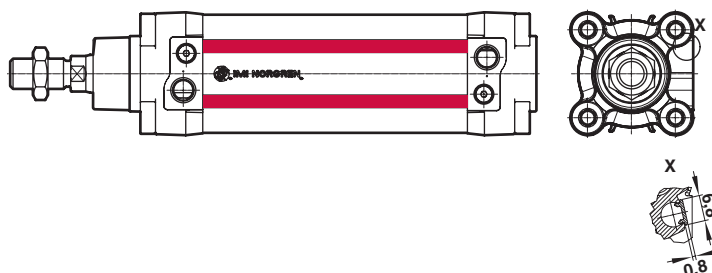

- > Magnetically operating reed switch - Round style
- > Suitable for all cylinder ranges with magnetic piston
- > Switches can be mounted flush with the delivered special adaptor
- > LED indicator on LSU models
- > Alternative variants allows a wide range of application



Technical features

Operation:

M/50/LSU Normally open with LED (yellow)

Switching voltage (U_b):

10 ... 240 V a.c./170 V d.c.

Switching voltage output:

U_b - 2,7 V

Switching current

(see graph overleaf):

0,18 A max.

Switching power:

10 W/10 VA max.

Contact resistance:

150 mΩ

Response time:

1,8 ms

Operating temperature:

-25 ... +80°C (-13°F ... +176°F)

High temperature version:

+150°C max.(+302 °F)

Protection rating (EN 60529):

IP 66

Shock resistance:

50 g (during 11 ms)

Vibration resistance:

35 g (at 2000 Hz)

Cable type:

2 x 0,25: PVC, PUR or silikon

3 x 0,25 PVC

Cable length:

2, 5 or 10 m

Electromagnetic compatibility

according to:

EN 60947-5-2

Materials:

Body: plastic

Cable: see table below

Technical data - Reed switches - additional information see data sheet en 4.3.005

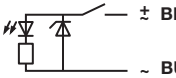
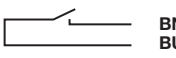
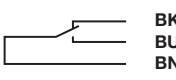
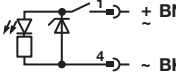
Symbol	Voltage		Current maximum (mA)	Function	Operating temperature (°C)	LED	Protection class	Plug	Cable length (m)	Cable type	Weight (g)	Model
	(V a.c.)	(V d.c.)										
	10 ... 240	10 ... 170	180	Normally open	-25 ... +80	•	IP 66	—	2, 5 or 10	PVC 2x0,25	37	M/50/LSU/*V
	10 ... 240	10 ... 170		Normally open								-25 ... +80
	10 ... 240	10 ... 170	180	Normally open	-25 ... +150	—	IP 66	—	2	Silicon 2x0,25	37	TM/50/RAU/2S
	10 ... 240	10 ... 170	180	Changeover	-25 ... +80	—	IP 66	—	5	PVC 3x0,25	37	M/50/RAC/5V
	10 ... 60	10 ... 60	180	Normally open	-25 ... +80	•	IP 66	M8x1	0,3	PVC 3x0,25	16	M/50/LSU/CP *1)
	10 ... 60	10 ... 60		Normally open				-25 ... +80				IP 66

* Insert cable length; *1) Plug-in connector see page 11

Dimensions

M/50/LSU/*V, M/50/LSU/5U,
TM/50/RAU/2S
Cable length L = 2, 5 or 10 m

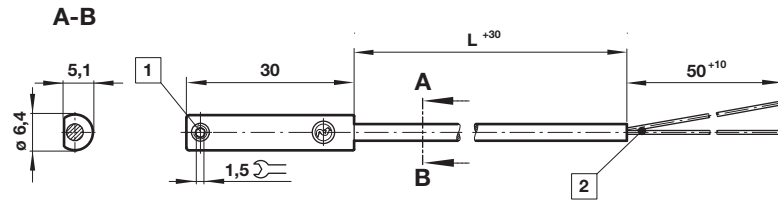

Dimensions in mm
Projection/First angle



M/50/RAC/5V
Cable length L = 5 m

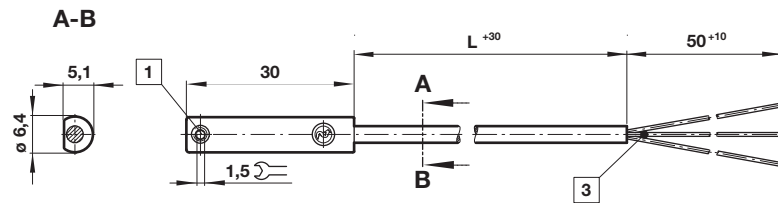

M/50/LSU/CP
M/50/LSU/CC

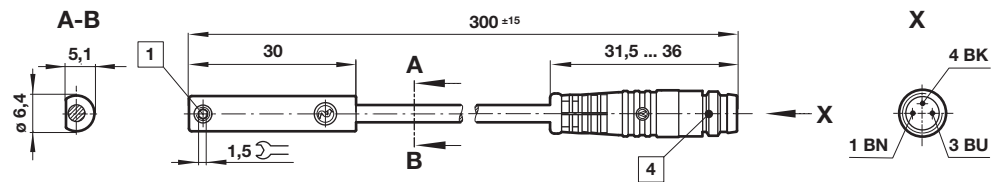

- 1 Fixing screw
- 2 + BN = brown; - BU = blue (output)
- 3 - BK = black; + BN = brown; - BU = blue
- 4 Version CP: Plug M8 x 1, color code: BK = +; BN = -; BU = output
Version CC: Plug M12 x 1, color code: BK = +; BN = -; BU = output

Accessories

Plug-in connector cable with nut



Outer cover	Cable length (m)	Weight (kg)	Connector	Model
PVC 3x0,25	5	0,18	M8x1	M/P73001/5
PUR 3x0,25	5	0,18	M8x1	M/P73002/5
PUR 3x0,34	5	0,21	M12x1	M/P34594/5

- > Magnetically operating Solid state - Round style
- > Magnetically operating switch, solid state
- > Easy IO link Version available
- > Suitable for all cylinder ranges with magnetic piston
- > Switches can be mounted flush with the delivered special adaptor
- > Resistance, reliable switching with a very fast response time
- > Particularly suited for use in high levels of vibration
- > LED indicator as standard
- > CE veriflicated
- > UL certificated



Technical features

Operation:

M/50/EAP (PNP) open collector output with LED (yellow)

M/50/EAN (NPN) grounded emitter output with LED (yellow)

M/50/IOP (PNP) Easy IO link open collector output with LED (yellow)

Switching voltage (Ub):

10 ... 30 V d.c.

Switching voltage output:

Ub - 2 V

Inducted voltage:

0,5 V

Switching current

(see graph overleaf):

150 mA max.

Switching power:

4,5 W max.

Response time:

< 0,5 ms

Operating frequency:

5 kHz

Protection rating (EN 60529):

IP 67 (standard)

IP 68 for type: M/50/EAP/5U

Operating temperature:

-40 ... +80°C (-40 ... 176°F)
(IP 67 & IP 68)

Cable type:

PVC 3 x 0,12 (standard)

PUR 3 x 0,14 (M/50/EAP/5U)

Cable length:

2, 5 and 10 m

Electromagnetic compatibility

according to:

EN 60947-5-2

Materials:

Body: plastic

Cable: see table below

Technical data - Solid state - additional information see data sheet en 4.3.007

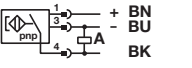
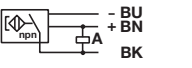
Symbol	Voltage (V d.c.)	Current maximum (mA)	Function	IO Link easy *2)	Operating temperature (°C)	LED	Protection class	Plug	Cable length (m)	Cable type	Weight (g)	Model
	10 ... 30	150	PNP	.	-40 ... +80	•	IP 67	—	2,5 or 10	PVC 3 x 0,12	37	M/50/EAP/*V
	10 ... 30	150	PNP	.	-40 ... +80	•	IP 67	—	5	PVC 3 x 0,12	37	M/50/IOP/5V
	10 ... 30	150	PNP	.	-40 ... +80	•	IP 68	—	5	PUR 3 x 0,14	37	M/50/EAP/5U
	10 ... 30	150	PNP	.	-40 ... +80	•	IP 67	M8 x1	0,3	PVC 3 x 0,14	16	M/50/EAP/CP *1)
	10 ... 30	150	PNP	.	-40 ... +80	•	IP 67	M8 x1	0,3	PVC 3 x 0,14	16	M/50/IOP/CP *1)
	10 ... 30	150	PNP	.	-40 ... +80	•	IP 67	M12 x1	0,3	PVC 3 x 0,14	16	M/50/EAP/CC *1)
	10 ... 30	150	NPN	.	-40 ... +80	•	IP 67	—	2,5 or 10	PVC 3 x 0,12	37	M/50/EAN/*V
	10 ... 30	150	NPN	.	-40 ... +80	•	IP 67	M8 x1	0,3	PVC 3 x 0,14	16	M/50/EAN/CP *1)

* Insert cable length; *1) Plug-in connector below; Color code: BK = black, BN = brown, BU = blue

IO Link easy function

- Optical Adjustment
- Counter
- Temperature diagnostic
- Power LED

Dimensions

M/50/IOP/5V

Cable length L = 2, 5 or 10 m

Dimensions in mm
Projection/First angle

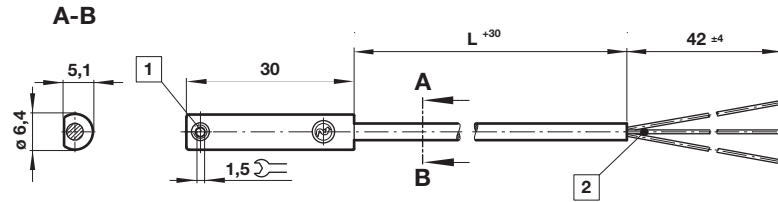

M/50/IOP/CP

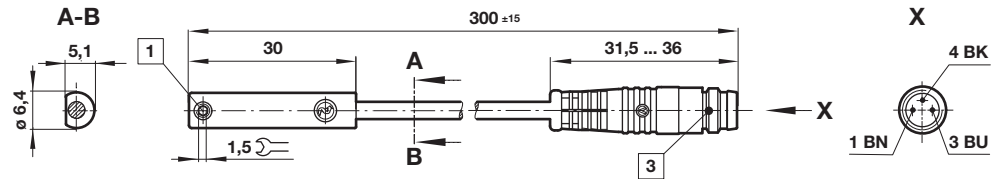

M/50/EAP/CC

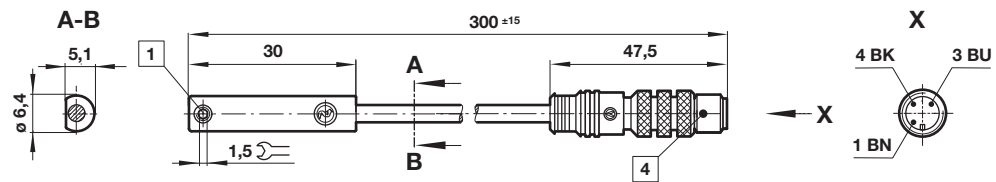

- 1 Fixing screw
- 2 Color code:
BK = black; BN = brown; BU = blue
- 3 Plug M8 x 1
- 4 Plug M12 x 1

Accessories

Plug-in connector cable with nut



Outer cover	Cable length (m)	Weight (kg)	Connector	Model
PVC 3x0,25	5	0,18	M8x1	M/P73001/5
PUR 3x0,25	5	0,18	M8x1	M/P73002/5
PUR 3x0,34	5	0,21	M12x1	M/P34594/5

QM/27/2/1 – Switch mounting brackets for Round barrel

Switch: M/50



ø	A	B	L	Weight (kg)	Model
32	9	6	12	0,010	QM/27/2/1
40	9	7	12	0,010	QM/27/2/1
50	7	5	12	0,010	QM/27/2/1
63	7	6	12	0,010	QM/27/2/1
80	4	4	12	0,010	QM/27/2/1
100	3	2	12	0,010	QM/27/2/1

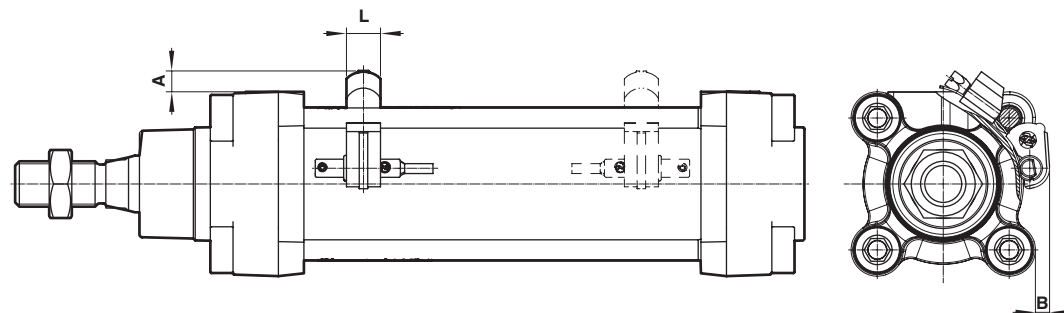

- > Magnetically operating Reed switch & Solid state - Block style
- > Suitable for all Rond barrel cylinder with magnetic piston
- > Alternative materials allows a wide range of application
- > Switch with plug



Technical features

Operation:

TQM/31, QM/32 normally open with LED (yellow)

Switching voltage (Ub):

10 ... 240 V a.c./d.c.

Switching voltage output:

Ub - 2 V (QM/32)

Switching current

(see graph overleaf):

1 A max. (QM/32)

Switching power:

50 W/50 VA max.

Contact resistance:

100 mΩ

Response time:

3 ms

Operating temperature:

-20 ... +80°C (-4 ... +176°F)

High temperature version:

+150°C max. (TQM/31) (+302°F)

Protection rating (EN 60529):

IP 66

Shock resistance:

50 g (during 11 ms)

Vibration resistance:

35 g (50 to 2000 Hz)

Cable type:

PVC 2 x 0,75, PUR 2 x 0,75

VMQ 2 x 0,75 (TQM/31)

Cable length:

2, 5 or 10 m

Electromagnetic compatibility

according to:



EN 60947-5-2

Materials:

Body: plastic

Cable: see table below

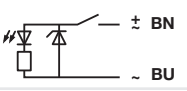
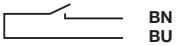
Technical data - Reed switches - additional information see data sheet en 4.3.021

Symbol	Voltage (V a.c./V d.c.)	Current maximum (A)	Function	Temperature (°C)	LED	Protection class	Features	Cable length (m)	Cable type	Weight (g)	Model
	10 ... 240	1	Normally open	-20 ... +80	•	IP 66	—	2, 5 or 10	PVC 2x0,75	108 (2 m)	QM/32/*
	10 ... 240	1	Normally open	-20 ... +80	•	IP 66	—	2	PUR 2x0,75	108	QM/32/2/PU
	10 ... 240	2	Normally open	-20 ... +150	—	IP 66	High temperature	2, 5 or 10	Silicon 2x0,75	102 (2 m)	TQM/31/*
	10 ... 240	1	Normally open	-20 ... +80	•	IP 66	Plug M12 x1	—	—	15	QM/32/P *1)

Technical data - Solid state - additional information see data sheet en 4.3.025

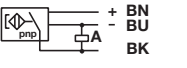
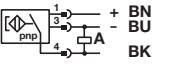
Symbol	Voltage (V d.c.)	Current maximum (mA)	Function	Temperature (°C)	LED	Protection class	Features	Cable length (m)	Cable type	Weight (g)	Model
	10 ... 30	200	PNP	-20 ... +80	•	IP 66	—	2, 5 or 10	PVC 3x0,5	102 (2 m)	QM/132/*
	10 ... 30	200	PNP	-20 ... +80	•	IP 66	—	5	PUR 3x0,34		QM/132/5/PU
	10 ... 30	200	PNP	-20 ... +80	•	IP 66	Plug M12 x1			15	QM/132/P *1)

* Insert cable length

*1) Plug-in connector see page below; Color code: BK = black, BN = brown, BU = blue

Dimensions

TQM/31, QM/32, QM/132

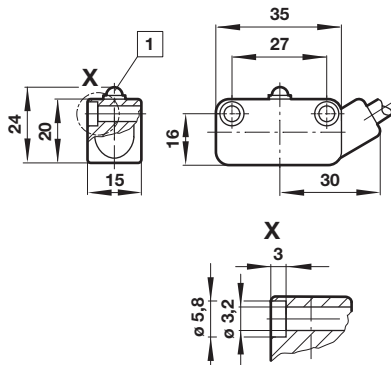

QM/32/P, QM/132/P

Dimensions in mm
Projection/First angle

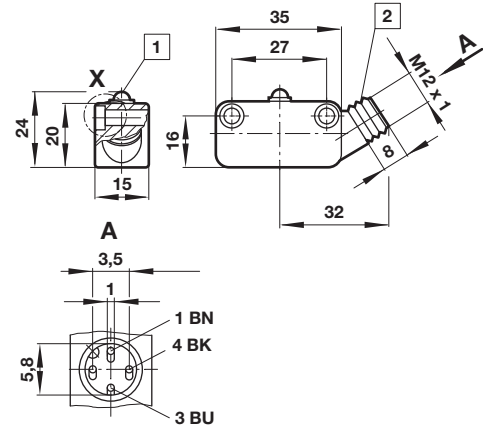

- 1 LED (yellow)
- 2 Plug M12 x1
Color code
BK = black
BN = brown
BU = blue

Accessories

Plug-in connector cable with nut



Outer cover	Cable length (m)	Weight (kg)	Connector	Connector
PVC 3x0,34	5	0,21	M12x1	M/P34692/5
PUR 3x0,34	5	0,21	M12x1	M/P34594/5

QM/31/000/22 – Switch mounting brackets for Round barrel Switches: TQM/31, QM/32, QM/132

Cy. ø	A	B	Weight (kg)	Model
32	5	42	0,026	QM/31/032/22
40	4,5	46	0,026	QM/31/032/22
50	4,5	50,5	0,026	QM/31/032/22
63	4	56,5	0,026	QM/31/032/22
80	2	62,5	0,028	QM/31/080/22
100	1,5	70,5	0,028	QM/31/080/22

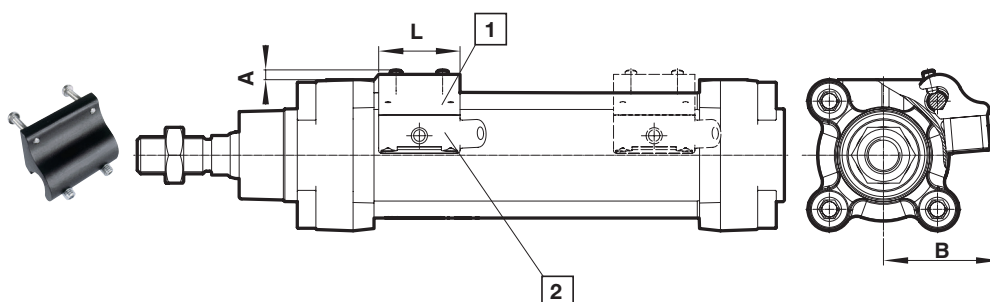

- 1 Bracket
- 2 Switch

- > **Pneumatic proximity sensor**
- > **Port size: \varnothing 3 mm**
- > **Optical pressure indicator signals position**
- > **Non-contact sensing with pneumatic output**
- > **Intrinsically safe – no problem in explosion areas**

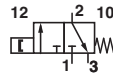

Technical features

Medium:

Compressed air, filtered and non-lubricated

Operation:

Pneumatic proximity switch for non-contact sensing via a magnetic field

Operating pressure:

2 ... 6 bar (29 ... 87 psi)

Connections:

Pipes for 3 mm I/D tubing

Vibration resistance:

10 ... 50 Hz (to IEC 68 T. 2-27)

Shock resistance:

500 m/s² over a period of 5 ms (to IEC 68 T. 2-27)

Flow rate:

40 l/min

Orifice size:

2 mm

Repeatability:

\pm 0,2 mm

Can be used with cylinder:

\varnothing 32 ... 100 mm

Operating temperature:

-15 ... +60°C (+5 ... +140°F)

Humidity and water content:

Air supply must be dry.

Corresponding of the application and working conditions the air must be dry enough to avoid condensate. The pressure dewpoint must be minimum 15°C under the application and working conditions.

Materials

Body: Plastic

Pipe connectors: Brass

Holding strap: CU ZU 37 (brass)

Pneumatic proximity sensor - additional information see data sheet en 4.3.061

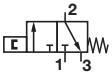
Symbol	Operating pressure	Flow rate	Orifice size	Optical indicator	Connections	Model
	2 ... 6 bar	40 l/min	2 mm	.	Pipes for 3 mm I/D tubing	QM/140

Dimensions

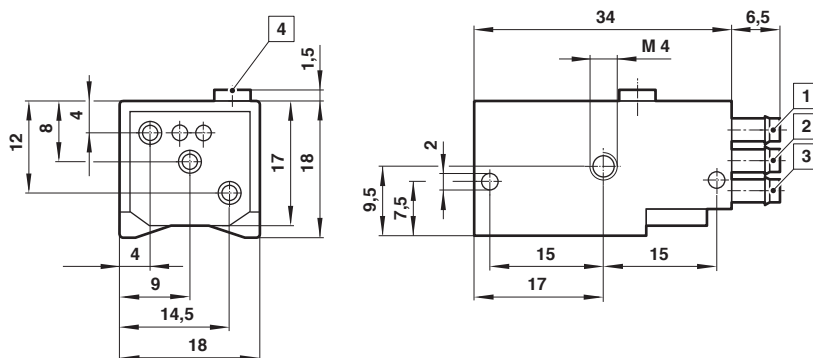

- 1 Compressed air port 1
- 2 Output port 2
- 3 Exhaust port
- 4 Optical indicator

QM/140/010/22 – Bracket with holding strap
Pneumatic switch: QM/140

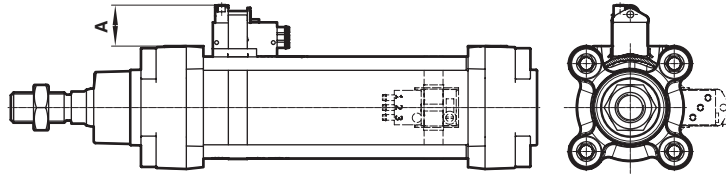
 Dimensions in mm
 Projection/First angle

∅	A (Round barrel)	(kg)
32	22	0,020
40	23	0,020
50	22	0,020
63	24	0,020
80	23	0,020
100	24,5	0,020

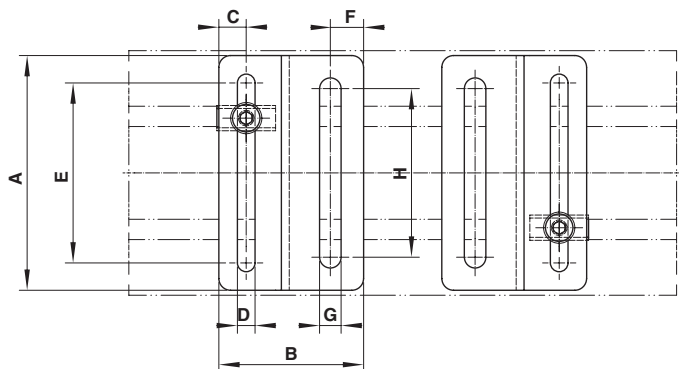
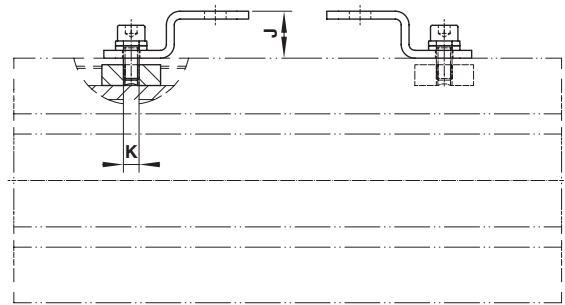
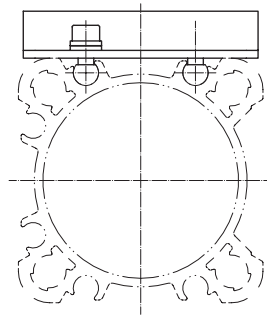
Valve mounting kit for Profile barrel

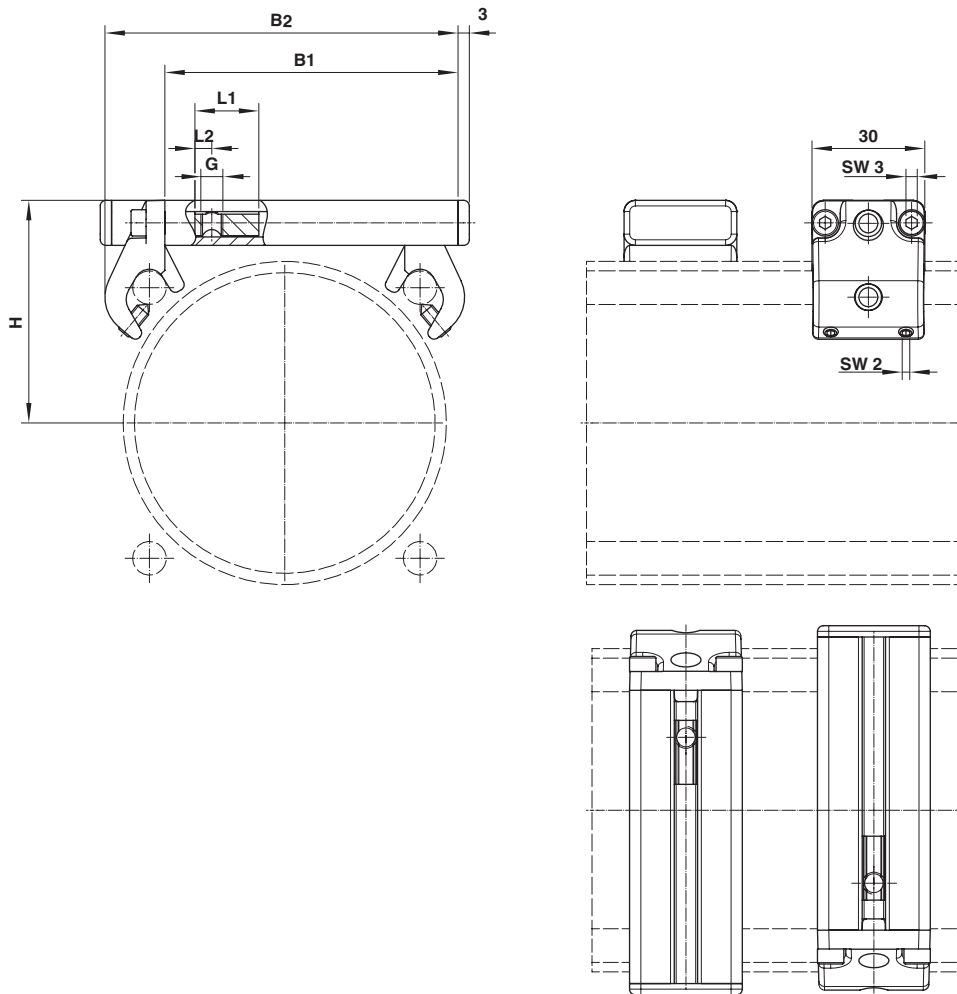

∅	A	B	C	D	E	F	G	H	J	K	SW	(kg)	Model
50/63	60	37	7	4,5	46	8,5	5,5	43	12	M4	3	0,08	PQA/802050/22/54
80/100	90	37	7	4,5	76	8,5	6,5	70	12	M4	3	0,11	PQA/802080/22/54

Valve mounting kit for Round barrel

 Dimensions in mm
 Projection/First angle

ø	B1	B2	H	L1	L2	G	kg	Model
63	61,5	77,5	50	17	4,5	M4	0,13	QA/8063/22/55/4
63	61,5	77,5	50	17	4,5	M5	0,13	QA/8063/22/55/5
63	61,5	77,5	50	17	4,5	M6	0,13	QA/8063/22/55/6
80	78	94	59,5	17	4,5	M4	0,14	QA/8080/22/55/4
80	78	94	59,5	17	4,5	M5	0,14	QA/8080/22/55/5
80	78	94	59,5	17	4,5	M6	0,14	QA/8080/22/55/6
100	97	113	68	17	4,5	M4	0,19	QA/8100/22/55/4
100	97	113	68	17	4,5	M5	0,19	QA/8100/22/55/5
100	97	113	68	17	4,5	M6	0,19	QA/8100/22/55/6

Recommended Valves

						Recommended Valve Range	
Cylinder	Tubing	Valve	Inline Valve V60		ISO Valve		
							
ø	Port size	ø	Flow l/min	Valve port size			
32	G1/8	6/4	250	1/8"	V60		
40	G1/4	6/4	250	1/8"	V60		
50	G1/4	6/4	250	1/8"	V60		
63	G3/8	8/6	750	1/8"	V60		
80	G3/8	10/7	1250	1/4"	V61	ISO Star UM/22000	
100	G1/2	10/7	1250	1/4"	V61	ISO Star UM/22000	

Customer Solution Cylinder valve unit For additional information please contact the technical service

Warning

These products are intended for use in industrial compressed air systems only. Do not use these products where pressures and temperatures can exceed those listed under »**Technical features/data**«.

Before using these products with fluids other than those specified, for non-industrial applications, life-support systems or other applications not within published specifications, consult Norgren GmbH.

Through misuse, age, or malfunction, components used in fluid power systems can fail in various modes.

The system designer is warned to consider the failure modes of all component parts used in fluid power systems and to provide adequate safeguards to prevent personal injury or damage to equipment in the event of such failure.

System designers must provide a warning to end users in the system instructional manual if protection against a failure mode cannot be adequately provided.

System designers and end users are cautioned to review specific warnings found in instruction sheets packed and shipped with these products.